



SKYMEN SONIC

Professional Ultrasonic Cleaning
Equipment Manufacturer

www.skymen.cc



Skymen Technology Corporation Limited

Office Tel: +86-0755-29784256(7*24h)

MOB./whatsapp/wechat: +86-13570830637(7*24h)

E-mail: info@skymen.cc

Website: www.skymen.cc

Marketing Center: Room 1103, Block B, Building 6, Zhonggang Plaza, Exhibition Bay, Fuyong Street, Baoan District, Shenzhen

R&D Center: Floor 1st & 2nd, Building 3, Tanggang Taifeng Industrial Park, Dawangshan Community, Shajing Street, Bao'an District, Shenzhen, Guangdong, China.

Production Base: Wujiang science and technology park, Wujiang district, Shaoguan city, Guangdong province (Skymen industrial park)





THREE BASES



Marketing Center

Room 1103, Block B,
Building 6, Zhonggang
Plaza, Exhibition Bay,
Fuyong Street, Baoan
District, Shenzhen.



R&D Center

Building 3, Tanggang
Taifeng Industrial Park,
Dawangshan Community,
Shajing Street, Baoan
District, Shenzhen.



Factory

Skymen Industrial Park,
Wujiang District,
Shaoguan City,
Guangdong, China.

COMPANY PROFILE

Skymen Technology Corporation Limited, which is a leading manufacturer and national high-tech enterprise, was founded in 2007. There are 2 factories of Skymen, one is located in Shenzhen, closed to HongKong. And the other is located in Shaoguan, Guangdong province, China.

We have been focusing on R&D of ultrasonic equipment & cleaning solution for more than 16 years with over 200 employee and plant size 20,000 square meter.

Products include CE, FCC, PSE, KC and other safety certification, as well as ROHS, PAHS, REACH, SCCP environmental certification, and passed the factory audit BSCI, ISO9001 quality management system.

There are more than 220 patents & certificates in total. Our products range covers homeuse ultrasonic cleaner, commercial ultrasonic cleaner, ultrasonic vibration rod series, ultrasonic vibration plate series, large hydrocarbon ultrasonic cleaning equipment with PLC, large ultrasonic cleaning equipment with vacuum implementation, etc.

SKYMEN CERTIFICATIONS



COMPANY STRENGTH

Skymen is a leading manufacturer and national high-tech enterprise, was founded in 2007. There are 2 factories of Skymen, one is located in Shenzhen, closed to HongKong. And the other is located in Shaoguan, Guangdong province, China. We have been focusing on R&D of ultrasonic equipment & cleaning solution for more than 16 years with over 200 employee and plant size 20,000 square meter.



COOPERATED CUSTOMERS

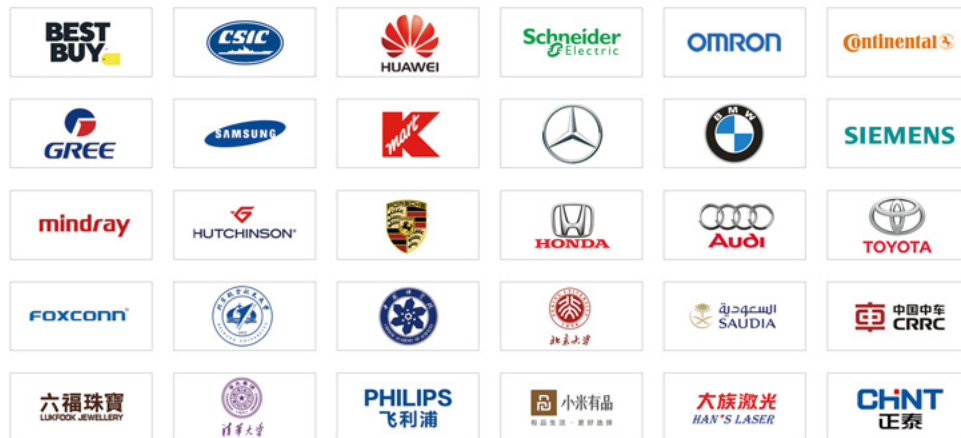

CONTENTS ▼

■ Benchtop Ultrasonic Cleaner	01
■ Single Tank Ultrasonic Cleaner	03
■ Single Tank Ultrasonic Cleaner With Filtration System	05
■ Double Tank Ultrasonic Cleaner	07
■ Multi-Tank Ultrasonic Cleaner	09
■ Automatic Ultrasonic Cleaner	11
■ Heat Exchanger Ultrasonic Cleaning Machine	13
■ Curtain Ultrasonic Cleaner	15
■ Semi-Automatic Ultrasonic Cleaning Equipment	17
■ Industrial Ultrasonic Transducer Box/Pack	19
■ Submersible Ultrasonic Transducer Bar	21
■ Customized Functions	23

Digital Control Panel Series Ultrasonic Cleaner

Widely use, special for medical and dental labs, scientific labs, industry, electronics and chemical experiments.

- ▶ Upgrade control panel, 20°slope control panel for easier operation.
- ▶ Semi-wave function, adjustable ultrasonic power for cleaning different item.
- ▶ Degas function, working for 9s and stopping for 6s to prevent oxidation reaction.
- ▶ Free stainless steel cleaning basket, better support for cleaning item.
- ▶ 304SUS materials, solid and durable.



Digital Upgrade New Series										
Model	JP-020S	JP-030S	JP-031S	JP-040S	JP-050S	JP-060S	JP-070S	JP-080S	JP-100S	JP-120S
Capacity(L)	3.2	4.5	6.5	10	14.5	15	20	22	30	38
Tank size(mm)	240*135*100	300*150*100	300*150*150	300*240*150	300*240*200	330*300*150	330*300*200	500*300*150	500*300*200	500*300*250
Overall size(mm)	270*185*230	330*200*235	375*200*275	380*290*280	370*270*325	400*350*280	400*330*330	585*330*280	585*327*333	585*345*385
Frequency	40KHz	40KHz	40KHz	40KHz	40KHz	40KHz	40KHz	40KHz	40KHz	40KHz
Ultrasonic power	120/60W	180/90W	180/90W	240/120W	300/150W	360/180W	480/240W	480/240W	600/300W	720/360W
Heating power	100W	200W	200W	200W	200W	300W	300W	500W	500W	800W
Timer	0-30min	0-30min	0-30min	0-30min	0-30min	0-30min	0-30min	0-30min	0-30min	0-30min
Temp setting	20-80°C	20-80°C	20-80°C	20-80°C	20-80°C	20-80°C	20-80°C	20-80°C	20-80°C	20-80°C

Mechanical Control Panel Series Ultrasonic Cleaner

Widely use, special for medical and dental labs, scientific labs, industry, electronics and chemical experiments.

- ▶ 304SUS materials, solid and durable.
- ▶ Free stainless steel cleaning basket, better support for cleaning item.
- ▶ Rotate button for temperature and time, controlled by users flexibly.
- ▶ Ultrasonic power cleaning, much more convenient for cleaning blind hole.
- ▶ OEM/ODM wholesale service.



Mechanical Series								
Model	JP-010	JP-020	JP-030	JP-031	JP-040	JP-060	JP-080	JP-100
Capacity(L)	2.0	3.2	4.5	6.5	10	15	22	30
Tank size(mm)	150*135*100	240*135*100	300*150*100	300*150*150	300*240*150	330*300*150	500*300*150	500*300*200
Overall size(mm)	180*165*205	270*185*230	330*200*235	375*200*275	380*290*280	400*350*280	585*330*280	585*327*333
Frequency	40KHz	40KHz	40KHz	40KHz	40KHz	40KHz	40KHz	40KHz
Ultrasonic power	80W	120W	180W	180W	240W	360W	480W	600W
Heating power	100W	100W	200W	200W	200W	300W	500W	500W
Timer	0-30min	0-30min	0-30min	0-30min	0-30min	0-30min	0-30min	0-30min
Temp setting	20-80°C	20-80°C	20-80°C	20-80°C	20-80°C	20-80°C	20-80°C	20-80°C

Single Tank Ultrasonic Cleaner

Skymen popular industrial ultrasonic cleaning machine, with good quality and high-performance cleaning, make cooperation with Samsung, Hitachi. Save labor, cleaning better.



Remove Oil



Remove Rust



Remove Dust



Remove Paint



Remove Rosin

Product Features

- ▶ Various capacity for cleaning different item size
- ▶ 1-99hours for cleaning time
- ▶ Machine in stock, shipped as soon as possible
- ▶ High frequency for better cleaning

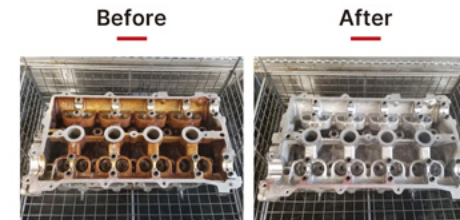

Model	Capacity	Frequency	Tank Size (mm)	Transducer (pcs)	Ultrasonic Power	Heating Power	Timer	Generator
JP-120ST	38L	28/40kHz	500*300*250	12	600W	1500W	1-99min	Built-in
JP-180ST	53L	28/40kHz	500*350*300	18	900W	1500W	1-99min	Built-in
JP-240ST	77L	28/40kHz	550*400*350	24	1200W	3000W	1-99min	Built-in
JP-300ST	99L	28/40kHz	550*450*400	30	1500W	3000W	1-99min	Built-in
JP-301ST	96L	28/40kHz	800*300*400	30	1500W	3000W	1-99min	Built-in
JP-360ST	135L	28/40kHz	600*500*450	36	1800W	4500W	1-99H	External
JP-480ST	175L	28/40kHz	700*500*500	48	2400W	6000W	1-99H	External
JP-600ST	264L	28/40kHz	800*600*550	60	3000W	6000W	1-99H	External
JP-720ST	360L	28/40kHz	1000*600*600	72	3600W	9000W	1-99H	External
JP-840ST	420L	28/40kHz	1500*700*400	84	4200W	15000W	1-99H	External
JP-960ST	480L	28/40kHz	1200*500*800	96	4800W	15000W	1-99H	External
JP-1108ST	540L	28/40kHz	1000*900*600	108	5400W	18000W	1-99H	External
JP-1120ST	640L	28/40kHz	1000*800*800	120	6000W	18000W	1-99H	External
JP-1132ST	800L	28/40kHz	1000*1000*800	132	6600W	24000W	1-99H	External
JP-1144ST	960L	28/40kHz	1200*1000*800	144	7200W	24000W	1-99H	External
JP-1216ST	1500L	28/40kHz	1500*1000*1000	216	10800W	36000W	1-99H	External

Single Tank Ultrasonic Cleaner With Filtration System

Ultrasonic cleaning machine with filtration system, cycle cleaning, specially for heavy oil and heavy dusty cleaning item. Save detergent, water, time and labor.



Additional Filter Tank



Y-type Filter



Filter Water Pump



Product Features

- ▶ Strong power and high frequency for deep and thorough cleaning, good for cleaning blind hole.
- ▶ Filter cleaning function, cycle cleaning, save time and labor.
- ▶ 2.0mm thick 304SUS materials, solid and durable.
- ▶ Adjustable power and temperature, controlled by users flexibly



Model	Capacity	Frequency	Tank Size (mm)	Transducer (pcs)	Ultrasonic Power	Heating Power	Timer	Generator
JP-120G	38L	28/40kHz	500*300*250	12	600W	1500W	1-99H	1 unit
JP-180G	53L	28/40kHz	500*350*300	18	900W	1500W	1-99H	1 unit
JP-240G	77L	28/40kHz	550*400*350	24	1200W	3000W	1-99H	1 unit
JP-300G	99L	28/40kHz	550*450*400	30	1500W	3000W	1-99H	1 unit
JP-301G	96L	28/40kHz	800*300*400	30	1500W	3000W	1-99H	1 unit
JP-360G	135L	28/40kHz	600*500*450	36	1800W	4500W	1-99H	1 unit
JP-480G	175L	28/40kHz	700*500*500	48	2400W	6000W	1-99H	1 unit
JP-600G	264L	28/40kHz	800*600*550	60	3000W	6000W	1-99H	2 units
JP-720G	360L	28/40kHz	1000*600*600	72	3600W	9000W	1-99H	2 units
JP-1108G	540L	28/40kHz	1000*900*600	108	5400W	18000W	1-99H	3 units
JP-1144G	960L	28/40kHz	1200*1000*800	144	7200W	24000W	1-99H	4 units
JP-1216G	1500L	28/40kHz	1500*1000*1000	216	10800W	36000W	1-99H	4 units

Double Tank Ultrasonic Cleaner

The 1st tank is equipped with filtration system, which effectively saves water and detergent. Then put the cleaned objects into the 2nd tank to quickly dry for the next process, thus improve the cleaning efficiency!

- 1 1st Tank: Ultrasonic Cleaning
- 2 2nd Tank: Drying



Product Features

- ▶ High quality stainless steel material is more durable and anti-corrosion.
- ▶ With filtration system, more environmentally friendly.
- ▶ With filtration system, saving labor cost, water and detergent.
- ▶ With drying function, quickly dry items ready for the next process.



Model	Capacity	Frequency	Tank Size (mm)	Ultrasonic Power	Heating Power	Timer	Dry Power	Drying Temperature
JP-2012GH	38L	28/40kHz	500*300*250	600W	1500W	1-99H	3000W	20-95°C
JP-2018GH	53L	28/40kHz	500*350*300	900W	1500W	1-99H	3000W	20-95°C
JP-2024GH	77L	28/40kHz	550*400*350	1200W	3000W	1-99H	3000W	20-95°C
JP-2030GH	99L	28/40kHz	550*450*400	1500W	3000W	1-99H	4500W	20-95°C
JP-2031GH	96L	28/40kHz	800*300*400	1500W	3000W	1-99H	4500W	20-95°C
JP-2036GH	135L	28/40kHz	600*500*450	1800W	4500W	1-99H	4500W	20-95°C
JP-2048GH	175L	28/40kHz	700*500*500	2400W	6000W	1-99H	6000W	20-95°C
JP-2060GH	264L	28/40kHz	800*600*550	3000W	6000W	1-99H	6000W	20-95°C
JP-2072GH	360L	28/40kHz	1000*600*600	3600W	9000W	1-99H	6000W	20-95°C
JP-2108GH	540L	28/40kHz	1000*900*600	5400W	18000W	1-99H	9000W	20-95°C
JP-2144GH	960L	28/40kHz	1200*1000*800	7200W	24000W	1-99H	12000W	20-95°C
JP-2216GH	1500L	28/40kHz	1500*1000*1000	10800W	36000W	1-99H	18000W	20-95°C

Multi-Tank Ultrasonic Cleaner

Cleaning Process:

- 01 Put the parts in 1st tank for ultrasonic cleaning with filtration system, cleaning media is tap water with detergent, cleaning time is about 15 minutes.
- 02 After 15 minutes, put the parts in 2nd tank for rinsing to wash away the cleaning agent and residual stains for a better cleaning effect. Media is only tap water, soaking the parts in 2nd tank about 5 minutes.
- 03 After 5 minutes, put the parts in 3rd tank for rinsing, media is only tap water, soaking the parts in 3rd tank about 5 minutes.
- 04 The last cleaning process for drying tank about 5-10minutes.

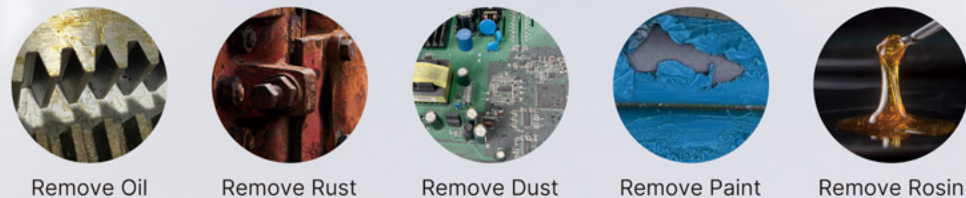

Product Features

- ▶ Fast and thoroughly cleaning
- ▶ Saving labor, time, detergent
- ▶ OEM/ODM wholesale service
- ▶ No damage for cleaning the parts
- ▶ Removing dirt and dust easily
- ▶ With emergency stop switch
- ▶ SUS 304/SUS 316 tank material
- ▶ Filtration system to filter floating debris
- ▶ Powerful and durable branded pumps
- ▶ Free stainless steel cleaning basket
- ▶ With water inlet/outlet in suitable place
- ▶ With stainless steel basket
- ▶ Double/Multi frequency is available



Model	Capacity	Frequency	Tank Size (mm)	Transducer (pcs)	Ultrasonic Power	Heating Power
JTM-3036GH	38L	28/40kHz	500*300*250	36	1.8KW	6KW
JTM-3054GH	53L	28/40kHz	500*350*300	54	2.7KW	6KW
JTM-3072GH	77L	28/40kHz	550*400*350	72	3.6KW	12KW
JTM-3090GH	99L	28/40kHz	550*450*400	90	4.5KW	12KW
JTM-3108GH	135L	28/40kHz	600*500*450	108	5.4KW	18KW
JTM-3144GH	175L	28/40kHz	700*500*500	144	7.2KW	24KW
JTM-3180GH	264L	28/40kHz	800*600*550	180	9KW	24KW
JTM-3216GH	360L	28/40kHz	1000*600*600	216	10.8KW	36KW
JTM-3252GH	420L	28/40kHz	1500*700*400	252	12.6KW	60KW
JTM-3288GH	480L	28/40kHz	1200*500*800	288	14.4KW	60KW
JTM-3324GH	540L	28/40kHz	1000*900*600	324	16.2KW	72KW
JTM-3360GH	640L	28/40kHz	1000*800*800	360	18KW	84KW
JTM-3396GH	800L	28/40kHz	1000*1000*800	396	19.8KW	96KW
JTM-3432GH	960L	28/40kHz	1200*1000*800	432	21.6KW	96KW

Automatic Ultrasonic Cleaner

The whole process of the automatic ultrasonic cleaner is fully automatic, and is controlled by a robot arm.

Cleaning range: Mechanical precision hardware, optical, ship, automobile and motorcycle, petroleum and kerosene, photovoltaic, rail transit, aerospace, semiconductor, electronics, mobile phone, battery.



Product Features

- ▶ Manipulator adopts robot arm, good safety.
- ▶ Imported Korean transducer, strong output power and long service life.
- ▶ New power supply, multi-function, uniform ultrasonic output.
- ▶ Automatic ultrasonic cleaning machine fully enclosed structure, no odor, beautiful.
- ▶ Adopt special washing basket for loading, good cleaning angle, good cleaning effect.
- ▶ PLC program control, the whole process is completed automatically.
- ▶ With in and out material table, very convenient for loading and unloading.
- ▶ Glass sight window, cleaning process is clear at a glance.
- ▶ Omron digital display temperature control, precise temperature control.
- ▶ Automatic ultrasonic cleaning machine using SUS304 stainless steel plate, no rust, durable.



Model	Capacity	Size of Every Tank (mm)	Ultrasonic Power	Heating Power of Ultrasonic Tank	Heating Power of Drying Tank	Transducer (pcs)
JTM-3024AD	38L*3	500*300*250	600W	1500W*2	1500W*2	24
JTM-3036AD	53L*3	500*350*300	900W	1500W*2	1500W*2	36
JTM-3048AD	77L*3	550*400*350	1200W	3000W*2	3000W*2	48
JTM-3060AD	99L*3	550*450*400	1500W	3000W*2	3000W*2	60
JTM-3072AD	135L*3	600*500*450	1800W	4500W*2	4500W*2	72
JTM-3096AD	175L*3	700*500*500	2400W	6000W*2	6000W*2	96
JTM-3120AD	264L*3	800*600*550	3000W	6000W*2	6000W*2	120
JTM-3144AD	360L*3	1000*600*600	3600W	9000W*2	9000W*2	144
JTM-3216AD	540L*3	1000*900*600	5400W	18000W*2	18000W*2	216
JTM-3288AD	960L*3	12000*1000*800	7200W	24000W*2	24000W*2	288

Heat Exchanger Ultrasonic Cleaning Machine

▼ Why should we need cleaning heat exchanger by ultrasonic?

After long-term operation of all types of heat exchangers, problems such as scaling and corrosion will inevitably occur. Those problem will affect the heat exchange efficiency and service life of the equipment. So heat exchanger should be scientifically cleaned and maintained once every year.

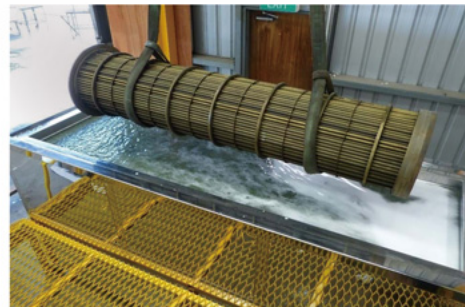

Heat exchanger ultrasonic cleaner-large tank ultrasonic cleaner with filtration system cleaning process:

- 01 Using a crane to place the cleaning basket with the heat exchanger into the ultrasonic cleaning tank, cleaning time is about 25 minutes
- 02 After 25 minutes, Lift the cleaning basket with a crane, and use the high-pressure water gun that comes with the machine to flush off the residual chemical and dirt,flushing time is about 5 minutes.

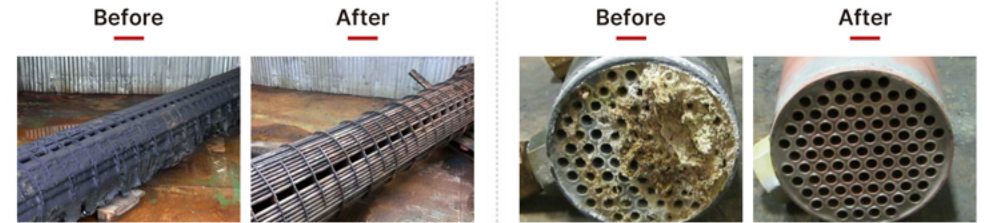

Heat Exchanger Ultrasonic Cleaner in different capacity(all size can be customized)

Model	Capacity	Tank Size (mm)	Transducer (pcs)	Ultrasonic Power	Heating Power
JP-1180G	1200L	1200*1000*1000	180	9KW	36KW
JP-1192G	1440L	1200*1200*1000	192	9.6KW	36KW
JP-1216G	1500L	1500*1000*1000	216	10.8KW	36KW
JP-1288G	1920L	2000*1200*800	288	14.4KW	36KW
JP-1360G	2400L	2000*1200*1000	360	18KW	42KW
JP-1432G	3600L	2000*1500*1200	432	21.8KW	42KW
JP-1576G	4500L	2500*1500*1200	576	28.8KW	42KW
JP-1648G	5400L	3000*1500*1200	648	32.4KW	48KW
JP-1720G	6400L	4000*1600*1000	720	36KW	48KW
JP-1936G	7280L	3500*1600*1300	936	46.8KW	48KW
JP-11152G	8500L	2500*2000*1700	1152	57.6KW	48KW
JP-11224G	9600L	3200*2000*1500	1224	61.2KW	54KW
JP-11368G	11520L	8000*1200*1200	1368	68.4KW	54KW
JP-11512G	20480L	8000*1600*1600	1512	75.6KW	60KW

Curtain Ultrasonic Cleaner

Ultrasonic is a revolutionary method of cleaning your blinds through the use of sound waves. Ultrasonic cleaning is fast, efficient, and completely safe. SKYMEN curtain ultrasonic cleaner can clean the vanes of blinds, as well as their cords, ladders, strings, and wands. Giving you with a new blind! Before you decide to replace your blinds, try cleaning them!

Application: Traditional fabric drape, venetian blind, roller shutters, honeycomb shade, cellular shades, honeycomb and pleated shades, roman shade, wood woven shade, bamboo curtain splint, reed screen shade, artificial fiber curtain



Product Features

- ▶ Fast and thoroughly cleaning
- ▶ Saving labor, time, detergent
- ▶ Drying rack between 2 tank
- ▶ Drain board to hold the wet curtain
- ▶ No damage to A2curtain
- ▶ Removing dirt and dust easily
- ▶ With emergency stop switch
- ▶ SUS 304/SUS 316 tank material
- ▶ With water inlet/outlet in suitable place
- ▶ With stainless steel basket
- ▶ Double/Multi frequency is available



Curtain ultrasonic cleaner cleaning process:

- 01 Put curtain in 1st tank for ultrasonic cleaning, cleaning media is tap water with detergent, cleaning time is about 15 minutes
- 02 After 15 minutes, put curtain in 2nd tank for rinsing, media is only tap water, soaking curtain in 2nd tank about 5 minutes, then put curtain on drain board.

Model	Capacity	Tank Size (mm)	Transducer (pcs)	Ultrasonic Power	Heating Power
JP-2036T	160L	2000*200*400	36	1.8KW	4.5KW
JP-2060T	264L	2400*220*500	60	3KW	6KW
JP-2072T	330L	3000*220*500	72	3.6KW	9KW

Semi-Automatic Ultrasonic Cleaning Equipment With Moving & Lifting Function

Composition: air cylinder + manual mobile trolley + air circuit + solenoid valve

Using SUS304 stainless steel bracket, the mobile trolley is installed on the bracket, with a pneumatic lifting mechanism, the position of the workpiece can be manually moved with a small force, and the user's operation is more convenient and labor-saving.



Cleaning Process:

- 01** Clamp the cleaning basket with the robotic arm on the loading table, and then move it up and down/left and right to the 1st tank for cleaning.
- 02** Set for 15 minutes for ultrasonic cleaning + bubbling rinse, and then move to the 2nd tank with the robotic arm after cleaning.
- 03** Using the high-pressure spraying function of the 2nd tank, it can wash the inside and outside of the workpiece, so that the stains remaining on the surface of the workpiece after ultrasonic cleaning can be washed down again.
- 04** After the cleaning of the two tanks, use the mechanical arm to move to the 3rd tank for air cutting, and quickly blow off the large particles of water droplets on the surface of the workpiece.
- 05** Use the robotic arm again to move the cleaning basket to the unloading table, and you will get a new workpiece.

Product Features

- ▶ Fast and thoroughly cleaning
- ▶ Saving labor, time, detergent
- ▶ Loading and unloading table
- ▶ No damage for cleaning the parts
- ▶ Removing dirt and dust easily
- ▶ With emergency stop switch
- ▶ SUS 304/SUS 316 tank material
- ▶ Convenient and practical with hydraulic lift
- ▶ With water inlet/outlet in suitable place
- ▶ With stainless steel basket
- ▶ Double/Multi frequency is available

Applications

- ▶ Auto Parts
- ▶ Medical Parts
- ▶ Hardware Parts
- ▶ Plastic Parts
- ▶ Aero Parts
- ▶ Labware Parts
- ▶ Optical Lens Parts
- ▶ Marine Parts
- ▶ Metal Parts
- ▶ Tools
- ▶ Electronic Parts



Model	Capacity	Frequency	Tank Size (mm)	Transducer (pcs)	Ultrasonic Power	Heating Power
JTM-4036GH	38L	28/40kHz	500*300*250	36	1.8KW	6KW
JTM-4054GH	53L	28/40kHz	500*350*300	54	2.7KW	6KW
JTM-4072GH	77L	28/40kHz	550*400*350	72	3.6KW	12KW
JTM-4090GH	99L	28/40kHz	550*450*400	90	4.5KW	12KW
JTM-4108GH	135L	28/40kHz	600*500*450	108	5.4KW	18KW
JTM-4144GH	175L	28/40kHz	700*500*500	144	7.2KW	24KW
JTM-4180GH	264L	28/40kHz	800*600*550	180	9KW	24KW
JTM-4216GH	360L	28/40kHz	1000*600*600	216	10.8KW	36KW
JTM-4252GH	420L	28/40kHz	1500*700*400	252	12.6KW	60KW
JTM-4288GH	480L	28/40kHz	1200*500*800	288	14.4KW	60KW
JTM-4324GH	540L	28/40kHz	1000*900*600	324	16.2KW	72KW
JTM-4360GH	640L	28/40kHz	1000*800*800	360	18KW	84KW
JTM-4396GH	800L	28/40kHz	1000*1000*800	396	19.8KW	96KW
JTM-4432GH	960L	28/40kHz	1200*1000*800	432	21.6KW	96KW

Industrial Ultrasonic Transducer Box/Pack

The ultrasonic transducer box/pack could make side vibration, bottom vibration and top vibration as required, providing 360° cleaning in the water. Fast heat dissipation and protection circuit enhancing the product service life.

The tank or outlook size, material, installation method and outlet location could be customized according to your requirements and cleaning needs.



Remove Oil Remove Rust Remove Dust Remove Paint Remove Rosin



Product Features

- ▶ Industrial quality & durable, with stable output and long service life
- ▶ Strong power and penetration, adjustable power, 360° cleaning
- ▶ Easy to use and simple to operate, it can be used after wiring without tedious operation
- ▶ Multiple and wide application, cleaning variety of products such as metal or non-metal
- ▶ Support customization, provide professional solutions to meet your requirements
- ▶ Warranty & After-sales service, provide 1 year warranty, and the transducer only be replaced without repairing

How to install it?

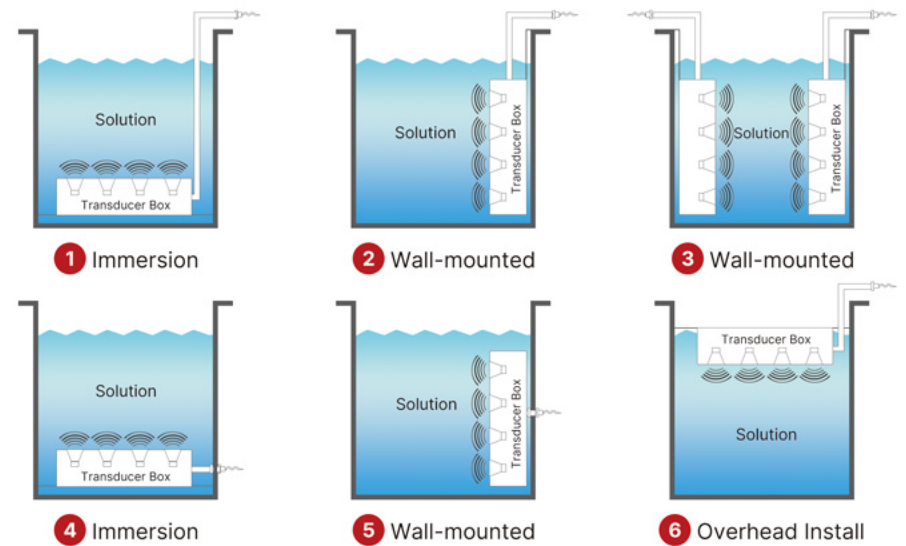

Model	Frequency	Unit Size (mm)	Ultrasonic Power	Transducer (pcs)	Tube Material
JP-1006I	28/40kHz	305*205*100	0-300W	6	Flexible / rigid tube
JP-1012I	28/40kHz	355*305*100	0-600W	12	Flexible / rigid tube
JP-1018I	28/40kHz	406*305*100	0-900W	18	Flexible / rigid tube
JP-1024I	28/40kHz	500*355*100	0-1200W	24	Flexible / rigid tube
JP-1030I	28/40kHz	550*406*100	0-1500W	30	Flexible / rigid tube
JP-1036I	28/40kHz	500*460*100	0-1800W	36	Flexible / rigid tube
JP-1048I	28/40kHz	600*460*100	0-2400W	48	Flexible / rigid tube

Submersible Ultrasonic Transducer Bar

The ultrasonic transducer bar uses the radial vibration of the internal transducer to uniformly generate ultrasonic waves around the bar.

The ultrasonic waves generate acoustic cavitation between the solution and the sample to achieve the purposes of cleaning, extraction, chemical reaction, anti-scaling, etc.

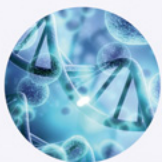

Biochemistry



Laboratory



Oil Industry



Cosmetics



Landscape River

Product Features

- ▶ Flexible operation. The ultrasonic transducer bar can be freely placed in any position of the cleaning tank, and it occupies a small volume space.
- ▶ Long service life and stable performance, sealed & waterproof.
- ▶ Support ODM & OEM customization, provide professional solutions to meet your requirements.
- ▶ Multiple uses. The ultrasonic transducer bar can be used for cleaning, emulsification, stirring, separation, homogenization, extraction, catalysis, defoaming, etc.



Assisted liquid exhaust defoaming

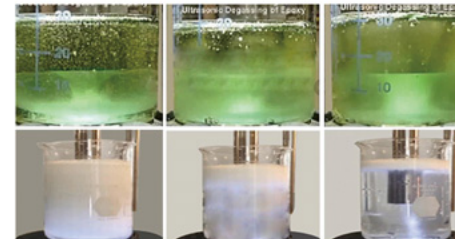

Dispersion and emulsification

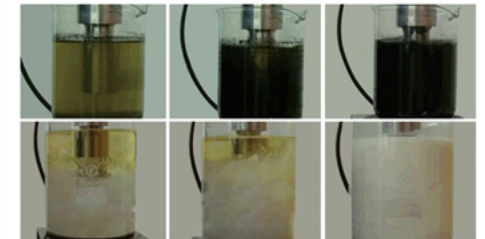

Model	Frequency	Length	Diameter	Ultrasonic Power	Transducer (pcs)
JP-1003M	28/40kHz	180mm	57mm	0-150W	3
JP-1006M	28/40kHz	300mm	57mm	0-300W	6
JP-1012M	28/40kHz	550mm	57mm	0-600W	12
JP-1018M	28/40kHz	750mm	57mm	0-900W	18
JP-1024M	28/40kHz	1000mm	57mm	0-1200W	24
JP-1036M	28/40kHz	1520mm	57mm	0-1800W	36

Filtration System

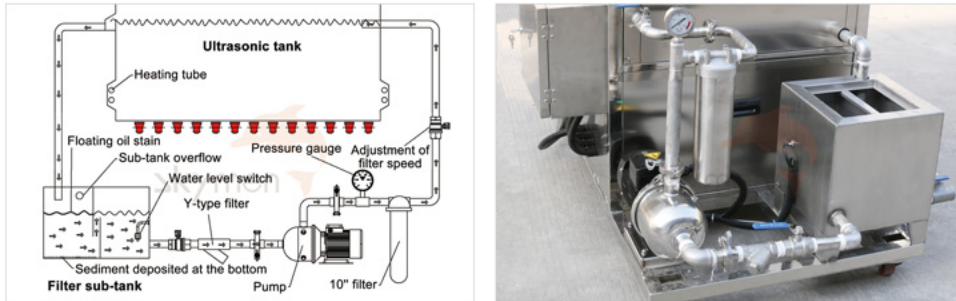

- **Composition:** water pump + filter sub-tank + filter bottle + pipeline + ball valve.
- **Principle Features:** Through the double-layer partition design of the filtration sub-tank, the primary filtration is performed to filter out large particle sediments, suspended solids and floating substances in the detergent; then the secondary fine filtration is performed by the filter bottle to filter out the small particles in the detergent. The welding part of the pipe elbow is welded by argon arc welding, and the surface is polished and polished to ensure that the welding appearance is beautiful.
- **Function:** Improve the utilization rate of cleaning solution. Reduced cleaning fluid costs. Avoid secondary pollution of workpiece. Save the labor of changing the cleaning solution.

Explosion-proof Cooling System



- **Composition:** explosion-proof electric box.
- **Principle Features:** The explosion-proof function is mainly explosion-proof electric box, explosion-proof grade BT6, which is used to protect the circuit from sparks or short circuits. Generally speaking, the whole machine is equipped with a set of explosion-proof electric box to prevent the machine from explosion due to potential safety hazards. the generator can achieve explosion-proof by extending the wire at least 5 meters away from the host (the generator can also be explosion-proof box, according to customer needs).
- **Function:** Protect the circuit from sparks or short circuits.

Spraying System

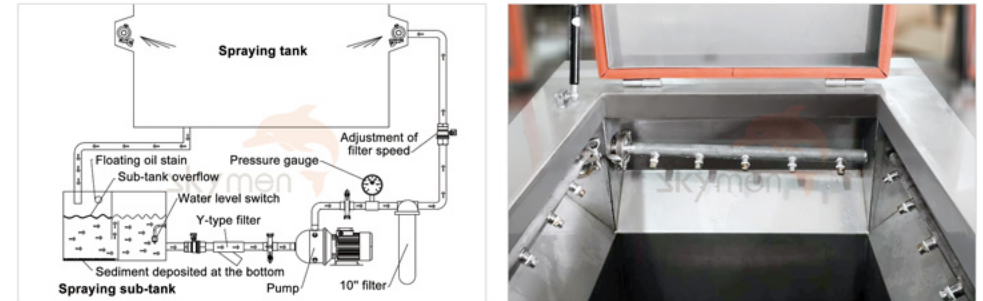

- **Composition:** water pump + spray pipe + fan nozzle + spray sub-tank + filter bottle + pipeline + ball valve.
- **Principle Features:** The high-pressure water pump sprays the liquid from the fan-shaped spray nozzle at a high speed, and the surface of the impacted workpiece has been softened, but the stains that have not been completely peeled off are completely peeled off and follow the spray water to flow through the filter bottle to be filtered. Equipped with a domestic well-known brand pump - Nanfang pump (head, flow rate is determined according to the size of the tank); stainless steel filter, filtration precision 1~50um optional.
- **Function:** Thoroughly peel off the stains on the workpiece. Make the remaining fine stains fall off again by high pressure spray.

Hot Air Drying System

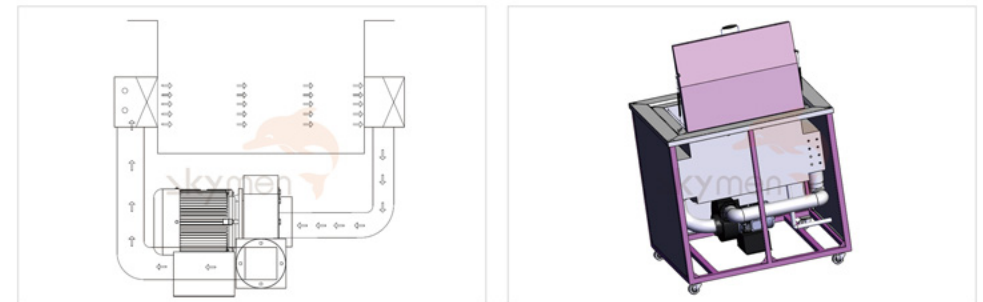

- **Composition:** heater + fan + blowing nozzle.
- **Principle Features:** According to the condition of the workpiece to be cleaned, it is equipped with a hot air drying system. The system is mainly composed of heaters, fans, blowing nozzles, etc. By using a certain temperature and using a high-power and high-speed high-pressure fan, the wind is strong and the noise is low. The hot air circulation drying can speed up the drying time of the cleaned workpiece, make the surface of the cleaned workpiece soaked in water dry quickly, and reduce the oxidation and rust caused by the residual water stains.
- **Application:** Widely used in optical electronics, LCD liquid crystal manufacturing, biomedicine, precision instruments, beverages and food, PCB printing and other industries with high cleanliness requirements.

Bubbling System

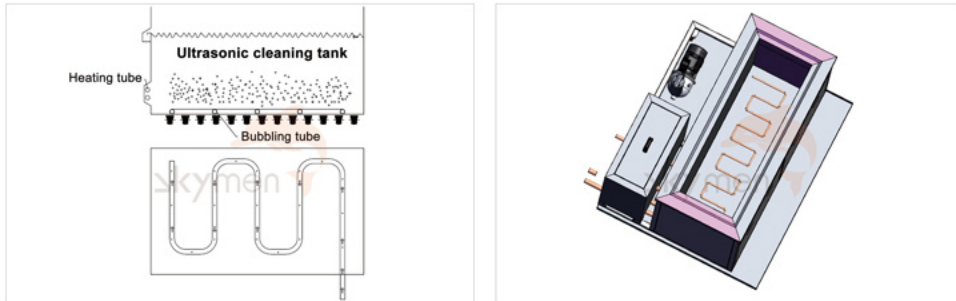

- ▶ **Composition:** Bubbling tube + compressed air.
- ▶ **Principle Features:** The compressed air is ejected through the small holes of the bubbling tube to generate high-pressure bubbles, so that the liquid in the tank is in a tumbling state, so that the lighter workpiece can be cleaned more comprehensively, and the stains deposited on the surface of the workpiece can be quickly peeled off.
- ▶ **Function:** Speed up stain peeling. Under strong air pressure, the objects can be more effectively peeled off and cleaned.
- ▶ **Other:** Install $\Phi 10\text{mm}$ stainless steel air pump, equipped with Japanese "SMC" air pressure control valve.

Agitation System



- ▶ **Composition:** motor (370w) + throwing wheel + throwing frame.
- ▶ **Principle Features:** When the motor drives the shaft to rotate, the outer edge of the throwing eccentric wheel pushes another part, causing the throwing frame to reciprocate up and down at a constant speed, thereby accelerating the peeling of stains and rapidly peeling off the deposits and attachments on the surface of the workpiece, so as to achieve fast, The purpose of comprehensive cleaning.
- ▶ **Function:** Speed up stain stripping. Effectively clean stubborn stains.

Lifting System

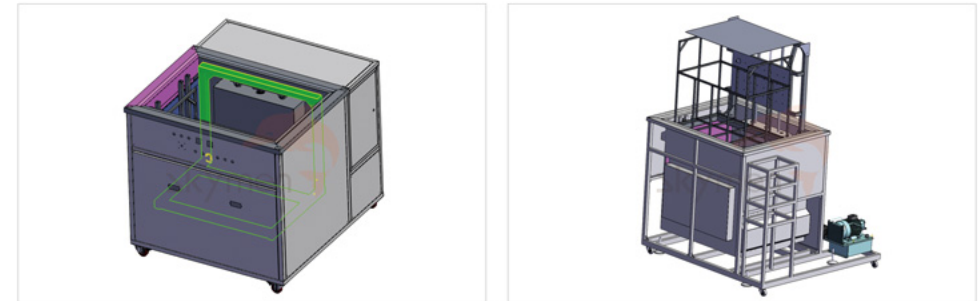

- ▶ **Composition:** oil pump (750w) + oil tank + hydraulic cylinder + lifting frame.
- ▶ **Principle Features:** Lifting mechanism consists of 4 major parts: walking mechanism, hydraulic mechanism, electric control mechanism, support mechanism. Hydraulic oil from the vane pump to form a certain pressure, through the oil filter, explosion-proof electromagnetic reversing valve into the lower end of the liquid cylinder, so that the piston of the liquid cylinder upward movement, lifting the weight; hydraulic oil through the explosion-proof electromagnetic reversing valve into the upper end of the liquid cylinder, the lower end of the liquid cylinder back to the oil tank through the balance valve, liquid-controlled check valve and other reversing valve, so that the weight down smoothly.
- ▶ **Function:** Save labor cost. Make it easier to clean large quality workpieces.

Stirring System



- ▶ **Composition:** motor (370w) + stirring paddle + stirring frame.
- ▶ **Principle Features:** The motor drives the stirring paddle to make the solution more uniform, so as to achieve more comprehensive cleaning. It is suitable for low viscosity liquid, suspension and dissolved liquid dispersion.
- ▶ **Function:** Make cleaning more fully dispersed solution.

For more product series and consulting services, please check the official website: www.skymen.cc